

## PANEL MOUNT COUPLING BODY ( NON VALVED)

Part #: **VCL12004**

Connection Type: Ferrule-less Tube Fitting

Material: Brass

Material Finish: Chrome Plated

Pressure Range: Vacuum to 250 psi, 17.3 bar

Temp. Range: -40°F to 180°F (-40°C to 82°C)

Mounting Option: Panel Mount

Tube size: 1/4" OD, .17" ID (6.4mm OD, 4.3mm ID)

Valve Option: Non-Valve

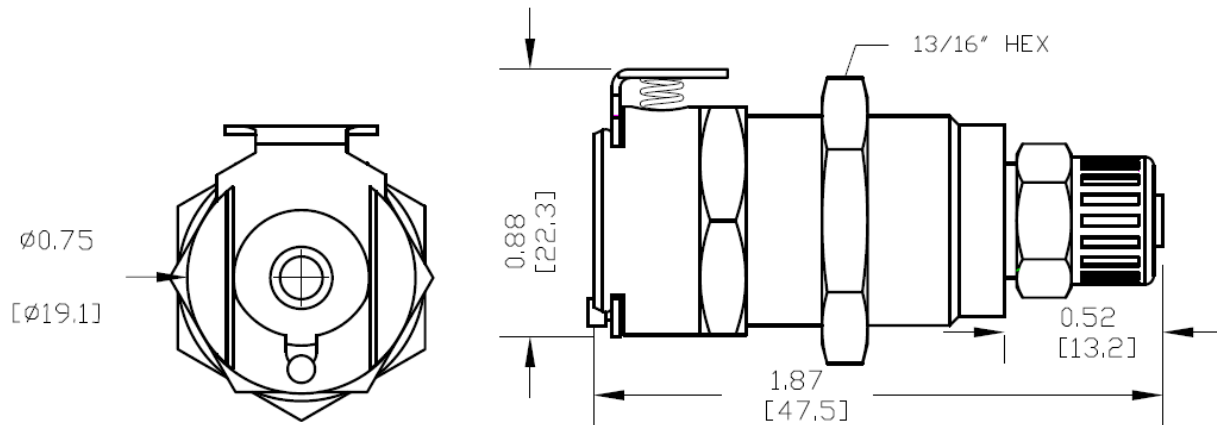

### Components:

Main Body: Chrome Plated Brass

Thumb Latch: Stainless Steel

External Spring: Stainless Steel

Seal: Nitrile